

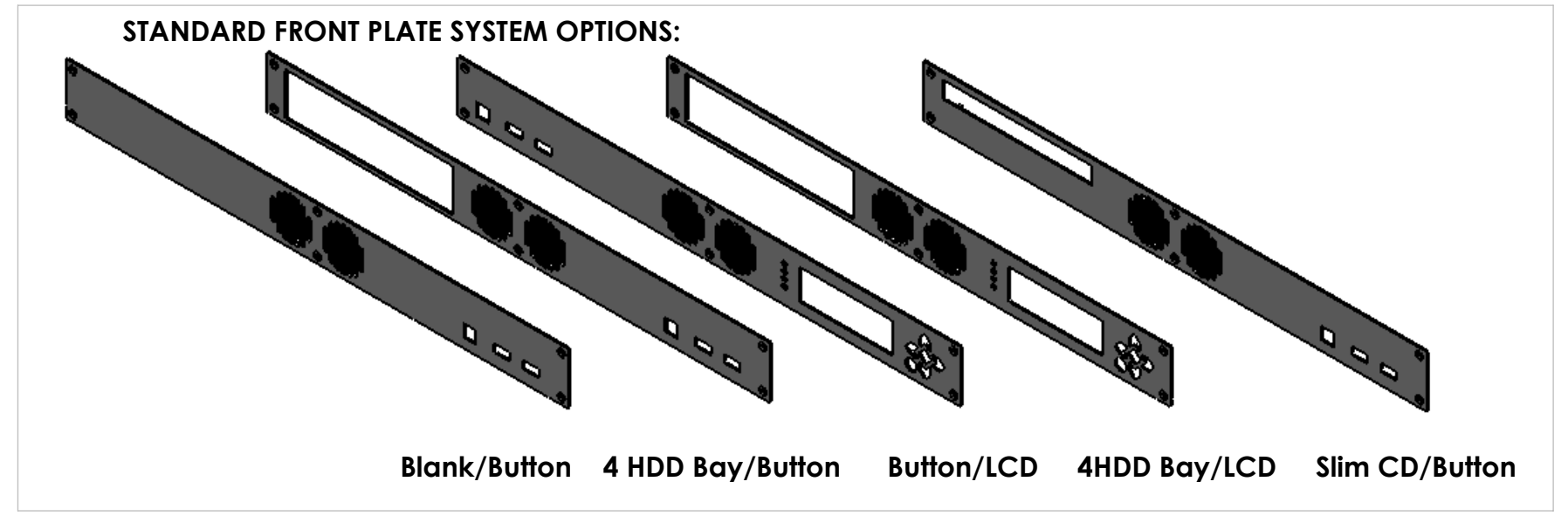

8 7 6 5 4 3 2 1

D
C
B
A

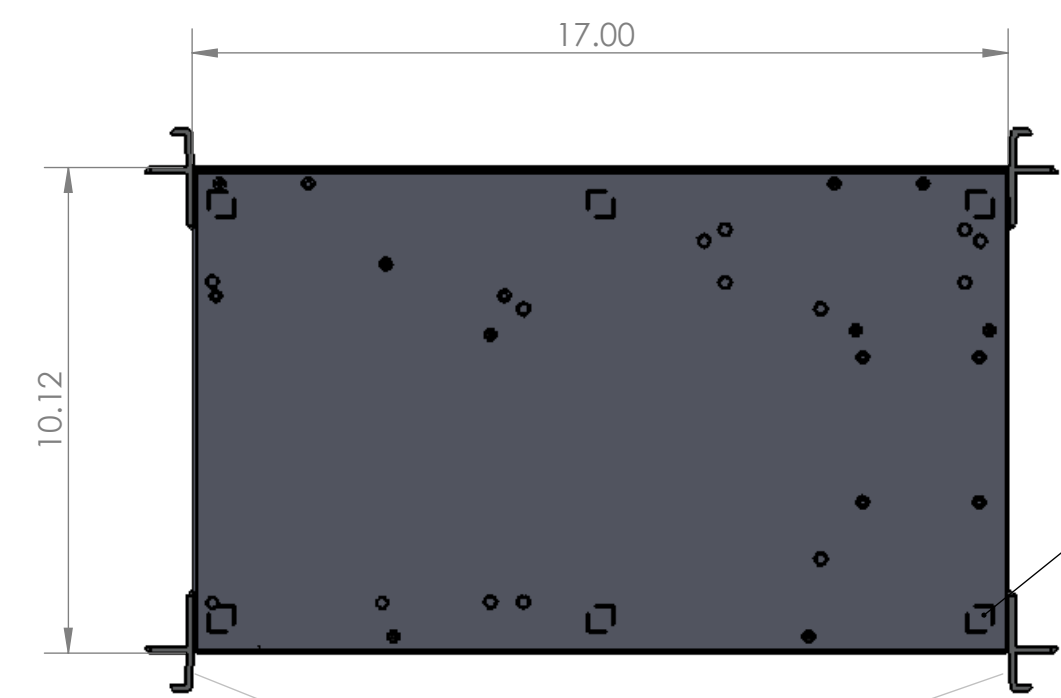
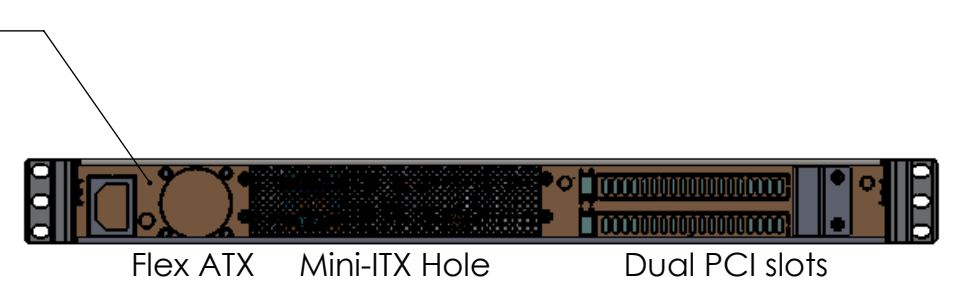
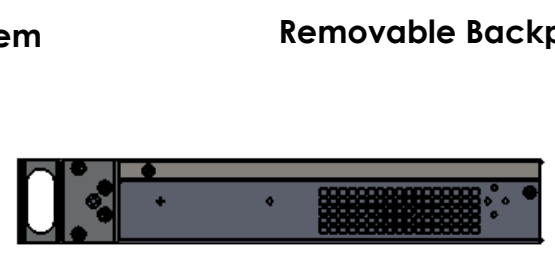
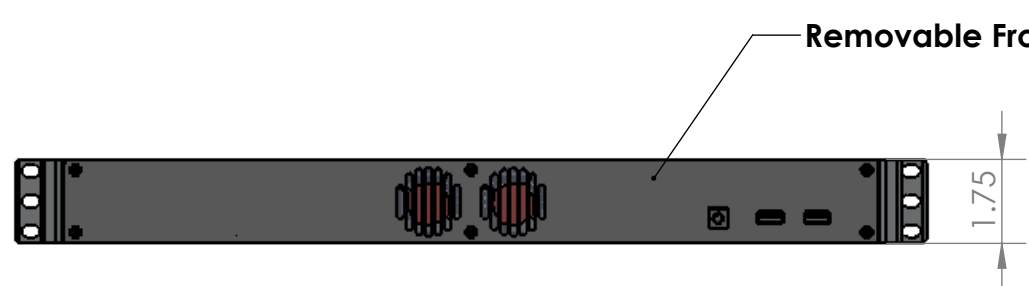
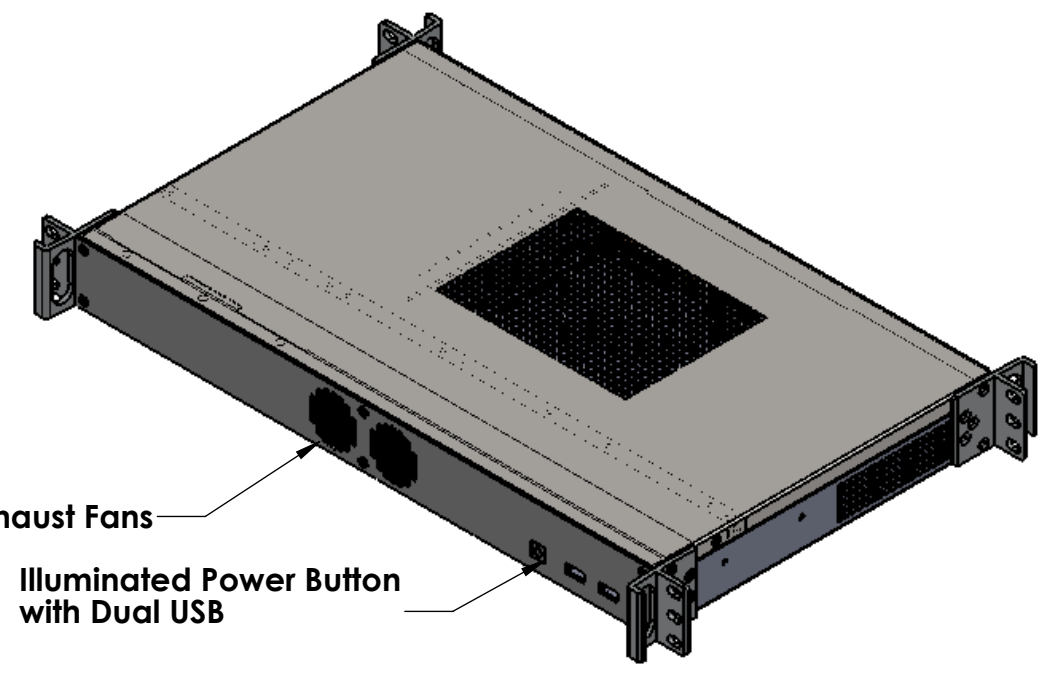
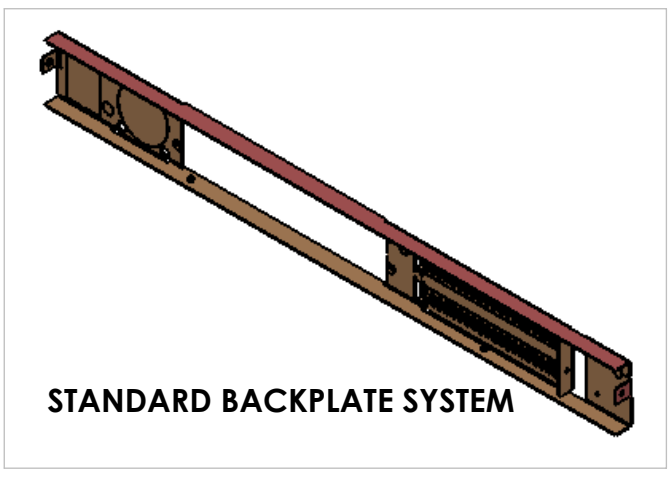
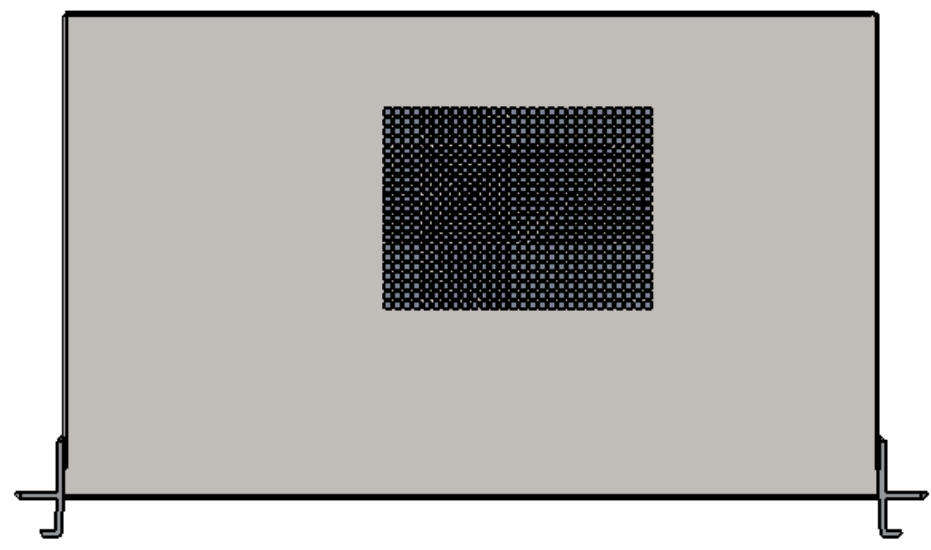

OPTIONAL: Rubber Feet (6x)

PROPRIETARY AND CONFIDENTIAL
THE INFORMATION CONTAINED IN THIS DRAWING IS THE SOLE PROPERTY OF LOGIC SUPPLY. ANY REPRODUCTION IN PART OR AS A WHOLE WITHOUT THE WRITTEN PERMISSION OF LOGIC SUPPLY IS PROHIBITED.

UNLESS OTHERWISE SPECIFIED:		NAME	DATE	 35 Thompson St S. Burlington, VT 05473 802-861-2300 www.logicsupply.com
DIMENSIONS AFTER PLATING OR OTHER PROCESS. TOLERANCES TO BE IN INCHES: X.X ± 0.1" X.XX ± 0.01" X.XXX ± 0.005" BEND ±1 deg		R.HILL	01/21/13	
INTERPRET GEOMETRIC TOLERANCING PER:		DRAWN		TITLE: Chassis, 1u Flex Chassis
MATERIAL		CHECKED		
FINISH		ENG APPR.		
DO NOT SCALE DRAWING		MFG APPR.		
NEXT ASSY	USED ON	Q.A.		SIZE B DWG. NO. 1090-5000_r02 REV 02
APPLICATION		COMMENTS:		
		SCALE: 1:4 WEIGHT:		SHEET 1 OF 1